

EVO13001231MAN

**UK/EU** English

EVOLUTION  
AQUA

INNOVATION IN WATER

evofeed  
AUTOMATIC

INSTALLATION AND OPERATING MANUAL

# WARNING: PLEASE READ THE FOLLOWING SAFETY INFORMATION FIRST.

## IMPORTANT SAFETY INFORMATION



- Keep out of reach of children
- When charging the battery, keep out of the rain, away from combustible or explosive materials.
- Built-in battery can't be stored in the condition of no power. If it is not used for a long time, please charge it for three hours every six months to maintain battery life.
- Do not use any other power adapter other than the one supplied.
- Always install at the side of a pond, never in the pond.
- Avoid exposure to direct sunlight.

## PRODUCT INFORMATION

**Capacity:** 6 Litres

**Feeding per day:** 1 - 6 times

**Lithium battery capacity:** 2200mA

**Adapter specification:** 12V 1.66A

**Dimensions:** 37 x 31 x 40cm

## Disposal Of Your Old Product

Your product is designed and manufactured with high quality material and components, which can be recycled and reused. When this crossed-out wheeled bin symbol is attached to a product, it means the product is covered by the European Directive 2002/96/EC. Please contact your local authority about correct disposal for electrical and electronic equipment. Our WEEE Registration Number is WEE/FE1471RR.

Please act according to your local rules and do not dispose of your old products with your normal household waste. The correct disposal of your old product will help prevent potential negative consequences for the environment and human health.

**UK  
CA**

**CE**



## INTRODUCING EVOFEED AUTOMATIC

evoFeed Automatic is an automatic fish feeder suitable for medium and large ponds.

The feeder can be programmed to dispense pond pellets into the pond at timed intervals, up to 6 times per day. The distance the food is propelled, and the amount of time it is dispensed for, are also adjustable. The food is propelled at a 120-degree angle.

Weatherproof, evoFeed Automatic can be mounted pond side, and is powered via its own built-in rechargeable battery.

Simply use the plug-in adaptor to charge the battery when needed.



evoFeed Automatic is ideal for Koi ponds, where large quantities of pellets are fed, and fish fed frequently throughout the day in order to maintain growth. It is also ideal for holiday feeding.

The feeder has a large LCD screen and control panel and can easily be set to feed up to six times daily. It is also possible to perform a manual feed from the control panel. The screen has a hinged, clear protective panel that prevents unintended interference with the touch buttons.

The feeder is designed to use pellets from 3-10 mm diameter. We do not recommend the use of sticks, flakes or other shapes of food.

The rechargeable lithium battery only needs an overnight charge indoors, to then operate for at least 3 months powered by its own battery, depending of the timer setting. Adapter for charging is included.

evoFeed Automatic is specially designed with a strong motor and extra bottom ventilation over the impeller to prevent the food from clogging.

Fixing pegs are included, which makes it easy to place and secure the feeder at the edge of your pond.

## SETTING UP THE FEEDER (STEP-BY-STEP)



1. Remove the feeder from the box.



2. Take the legs out of the food container and assemble as shown. These simply push-fit together.



3. Remove lid, turn the motor upside down, and mount the legs as shown.



4. Secure the legs to the motor, using the screws provided.



5. Use a screwdriver to unscrew the three screws to remove the motor cover.



6. Remove the motor cover. Take care not to lose the three screws.

## SETTING UP THE FEEDER (STEP-BY-STEP)



7. Take the battery from the packaging bag.

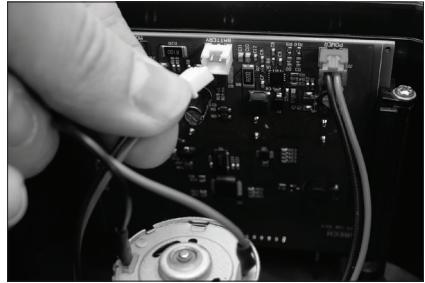

8. Fit battery plug into white socket labelled BATTERY on PCB board.

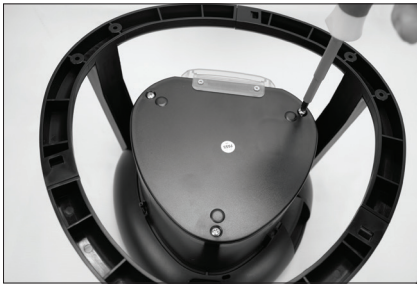

9. Re-fit the motor cover and screw the three screws to secure the cover.



10. We recommend plugging the charging adapter into the feeder and into the mains and leave to fully charge.



11. Pull the hinged protective panel. Set time by pressing SET once, then the UP / DOWN button, to set current hour. Then press SET, followed by UP / DOWN to set minutes.

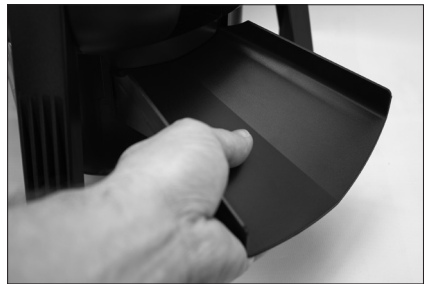

12. Fit feeding chute to the motor. Slide it upwards into the grooves.

# SETTING UP THE FEEDER (STEP-BY-STEP)

## Display overview

The touch panel provides an easy way to program your feeder.

"Set" saves and jump to the next input.

"Run" have 2 functions:

A. Short press saves and exit B. Long press distribute 3 seconds of food.

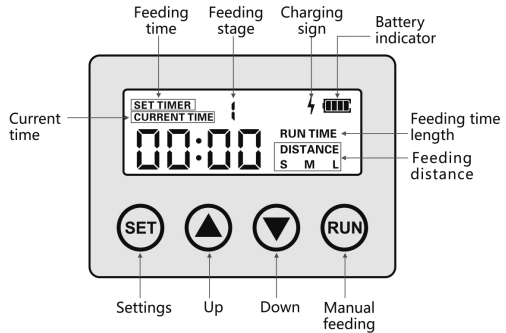

## How to set time and distance for the food

Depending on the size of your pond, you can set the feeder motor for 3 different distances.

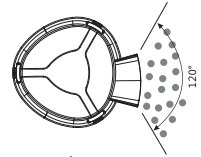

As a reference, normal 6 mm koi pellets have the following approximate spread:

**Short (60%):** 1 m.    **Medium (80%):** 2 m.    **Long (100%):** 3 m.

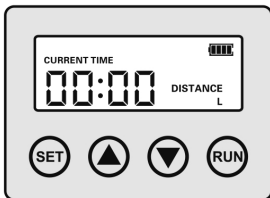

1. Press the 'SET' button, enter the current time; Hour and press SET, Minutes and press SET
2. Set the distance at Short (60%), Medium (80%) or Long (100%) as preferred and press SET.
3. Press the RUN button for 5 sec. to see distance

4. Test with your preferred food and repeat step 1-3 to find the best setting.

## How to set amount of preferred food

The timing and amount of food varies on the basis of the type, pellet size, and weight of the food.

You can set the timer up to 6 times a day for a feeding period of up to 20 seconds. As a reference, a handful of normal 6 mm koi pellets requires about 3-5 seconds of operation.

5. Set the timers for feeding time and amount of 2 min. ahead (follow timer instruction on next page 8-10)
6. Hold a plastic bag in front of the outlet and check the amount of food after the feeding.
7. Adjust the running time for your preferred amount of food by repeating step 5-6.

## SETTING UP THE FEEDER (STEP-BY-STEP)

### How to set the timer

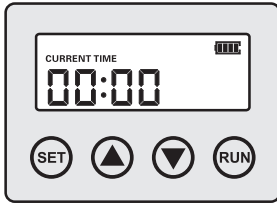

**8.** Press the 'SET' button past the time and distance setting (1-2)

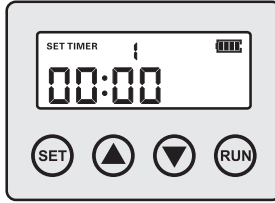

**9.** Choose the time you want your first feeding to occur and press 'SET'.

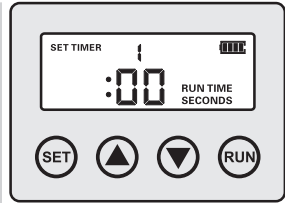

**10.** Choose the amount of food in seconds, up to 20 seconds and press 'SET'.

**11.** If you only want to set one or a few feeding times, you do not need to press 'set' all the way through the 6 options. You can just press "Run" shortly or wait about 5 seconds – then the feeder will automatically save your setting and resume normal operation.

**12.** To set up to 6 feedings, you will have to use the 'SET' button all the way through the 6 settings.

As an addition to the timer setting, you can always perform a manual 3 sec. feeding by pressing the 'RUN' button for around 5 seconds.

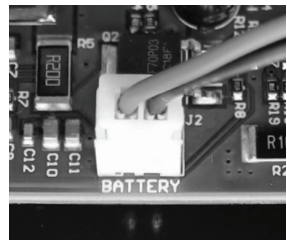
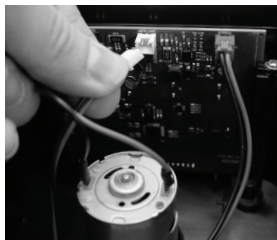
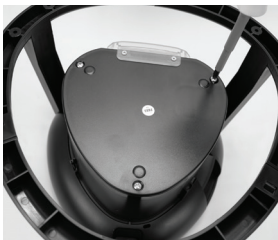

If you want to do a full reset you need to remove the battery wire for 30 seconds.

- Open the cover on the motor by removing the 3 screws.
- Locate the white connector labelled BATTERY, and remove it.
- Wait for 30 seconds, then re-connect it.
- Close the cover and re-fit the three screws.

## MAINTENANCE

Maintenance is not usually required, but depending on the type of food you use, the feeding operation might create some dust. If required, you can use a dry cloth to remove – the feeder is easily dismantled. If you wish to clean the food container with water, you need to dismantle it from the lower body first.

Make sure everything is dry before you reassemble, as water will damage the motor and electronics.

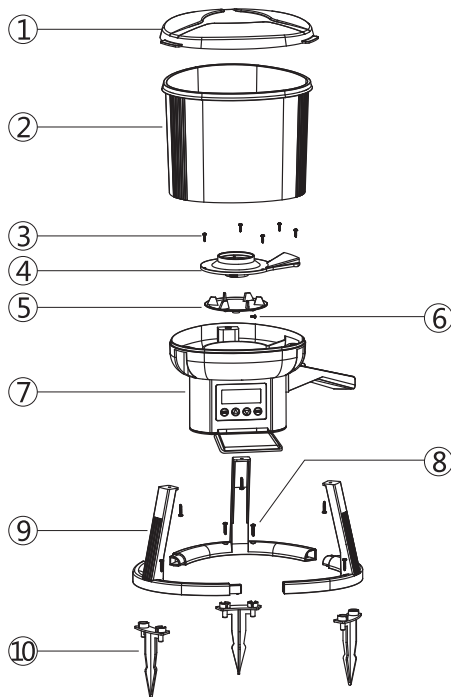

1. Container cover
2. Food container
3. Screws for impeller cover
4. Impeller cover
5. Impeller
6. Screw for impeller
7. Lower body with control panel, LCD-screen, protective cover, and battery (open bottom cover to access)
8. Screws for legs
9. Legs
10. Fixing pegs



## USE WITH EVOLUTION AQUA FOODS

Evolution Aqua's fish food range has been developed by people who not only care about fishkeeping, but have a proven know-how. We only use ingredients of the highest quality to promote all aspects of health, growth and development.



## GROWTH*Plus*

GrowthPlus is available in four sizes 800g, 2kg, 6kg, and 15kg, in 5-6mm (medium) pellet size.



## PREMIER

Premier is available in four sizes 800g, 2kg, 6kg, and 15kg, all in 2 pellet sizes; 3-4mm (small) and 5-6mm (medium).



## WHEATGERM

Wheatgerm is available in four sizes 800g, 2kg, 6kg, and 15kg, all in 2 pellet sizes; 3-4mm (small) and 5-6mm (medium).

Visit [www.evolutionaqua.com](http://www.evolutionaqua.com) for more information about our range of fish foods



## **GUARANTEE**

This product is guaranteed against defects in material and workmanship for 2 years from the date of purchase, under normal usage. The guarantee DOES NOT APPLY in case of improper use, negligence, lack of maintenance or accidental damage to the product. If the product fails due to a manufacturing fault within this period it will be either repaired or replaced free of charge.

The battery is not covered by warranty and can be ordered as a replacement part.

Liability is limited to replacement of the faulty product only; no other costs will be reimbursed. This guarantee is not transferable and does not affect your statutory rights. This guarantee does not confer any rights other than those expressly set out above.

The manufacturer or supplier shall not be responsible, or held liable for any damages caused by defective components or materials of this product; or for loss incurred by interruption of service; or any consequential / incidental damages and expenses arising from the production, sale use or misuse of this product or any other consequential loss.

Any warranty claim must be accompanied by a valid, dated proof of purchase.

Evolution Aqua and its dealers shall not be held liable for any loss of fish, plants or any other livestock as a result of any failure or defect of this product.

The installation and use of your product outside of our recommendations as printed in this manual may also void the warranty.

# VISIT OUR WEBSITE AND FOLLOW US ON SOCIAL MEDIA



For all the latest Evolution Aqua news sign up to our email newsletter to have the newest info delivered direct to your inbox. Keep up to date by following us on social media, join our Pond Owners Club on Facebook or check out our website for technical information and product advice at [www.evolutionaqua.com](http://www.evolutionaqua.com).



## INSTRUCTION MANUALS

Download instruction manuals for all Evolution Aqua products



## PARTS STORE

Find spare parts and accessories for Evolution Aqua products



## FAQS

Read frequently asked questions about Evolution Aqua products



## EMAIL NEWSLETTERS

Sign up to receive our email newsletters at [evolutionaqua.com/newsletter](http://evolutionaqua.com/newsletter)



## STOCKISTS

Locate your nearest Evolution Aqua product stockist



## EA POND OWNERS CLUB

Search Evolution Aqua Pond Owners Club on Facebook to join the community



## FACEBOOK

Keep updated with our latest news at [facebook.com/evolutionaqua](https://facebook.com/evolutionaqua)



## INSTAGRAM

Follow us on Instagram for updates at [instagram.com/evolution\\_aqua](https://instagram.com/evolution_aqua)



## TIKTOK

Follow us on TikTok at [tiktok.com/@evolution\\_aqua](https://tiktok.com/@evolution_aqua)



## YOUTUBE

Watch our YouTube channel at [youtube.com/evolutionaqualtd](https://youtube.com/evolutionaqualtd)

## Evolution Aqua Ltd

Kellet Close  
Wigan  
Lancashire  
United Kingdom  
WN5 0LP

[www.evolutionaqua.com](http://www.evolutionaqua.com)

EVOLUTION  
AQUA

INNOVATION IN WATER